

SERAMİK
TEKSTİL
MAKİNE
İTHAL-İÇİT

Çözüm Adresiniz...

ÖRGÜ MAKİNALARI
ÜRÜN KATALOĞU

HAKKIMIZDA

ABOUT US

Seramik Tekstil 2002 yılında Tekstil makinelerine yedek parça tedariki ve üretimi amacıyla kuruldu. Keramik Tekstil kurulduğu günden bu yana gerek yurtiçi gerekse yurtdışındaki müşterilerine hızlı ve kaliteli ürünleri tedarik ederek büyük bir büyüme göstererek ürün gamını genişletmiştir.

Seramik Tekstil Bayrampaşa'daki merkezi ve deposu ile müşterilerinin taleplerini hızlı bir şekilde sonuçlandırarak üretimlerinin kesintiye uğramaması için müşterilerinin çözüm ortağı konumuna gelmiştir.

Seramik tekstil Entegre tesisler için Örgü makineleri dışında dokuma, çorap, iç giyim, kablo vs. birçok üretimde kullanılmakta olan seramik yedek parça tedarikinde de aktif rol oynamaktadır. Örgü makinelerinde A-Z'ye mevcut kullanılan tüm ürünlerin tedarikini ve üretimini sağlayan bir firma olarak yeni teknoloji takip ederek müşterilerin gelişmesine de katkı sunmaktadır.

Firmamız sadece Türkiye'de değil Avrupa'da da (Dünya da ilk 5) en büyük ürün çeşidi ve stoğuna sahip olarak, aynı zamanda istediğiniz ürünlerin imalatını yaparak müşterilerinin büyük beğenisini kazanmıştır.

Seramik Tekstil, yaklaşık 6 bin çeşit ürünüyle, oluşturulması güç bir ürün yelpazesine sahip olmanın avantajlarını da en verimli biçimde kullanmaktadır. Tekstil Makinaları yedek parça konusunda Türkiye'nin en önemli markası haline gelmiştir.

Tekstil sektörüne en kaliteli ve en uygun fiyatlı ara mamul temin etmeyi ilke edinen firmamız, marka çalışmalarının temelini oluşturan, ürün geliştirme konusunda da önemli adımlar atıp sektördeki gelişmeleri yakından takip ederek, ürünlerini yenilemeyi sürdürmektedir.

Seramik tekstil, yurtiçinde ve yurtdışındaki fuarlara katılımcı olarak katılarak (ITMA,ITM,ITCE,GATEX,TEXPO) Mısır, Suriye, Cezayir, İran, Rusya, Doğu Asya ve birçok ülkelere de tedarikçi hizmeti sunmaktadır.

Seramik Textile supplies spare parts to textile machines in 2002. Since the day it was founded, Keramik Tekstil has expanded its product range by showing rapid growth by supplying fast and high quality products to our customers both at home and abroad.

Seramik Tekstil has to be to the solution partner of its customers in order to next off production of Bayrampaşa's headquarters and storage customers quickly.

Seramik Tekstil For integrated facilities In knitting machines weaving, socks, underwear, cable etc. are active in supplying ceramic spare parts for many production. Making on the supply and production of all the materials available for knitting machines than A to Z as a company to follow the new technology and contribute to the development of customers.

Our company has won the appreciation of its customers by making the products only in Europe (the top 5 in the world) with the biggest variety of products and products.

Seramik Tekstil uses the best form with about 6 thousand kinds of products, a productive power range and the best form. In the Textile Machinery has become Turkey's most important brand spare parts.

We are pleased to offer our highest quality and most affordable product range to the Textile Industry and we continue to innovate our products by taking important steps in product development which is the basis of brand studies and following up our sector developments soon.

Seramik Tekstil has been providing services to Egypt, Syria, Algeria, Iran, Russia, East Asia and many other countries by participating in trade fairs at home and abroad (ITMA, ITM, ITAC, GATEX, TEXPO).

İÇİNDEKİLER

INDEX

Likra Aparatı-Meminger & Yedek Parçaları Lycra - Yarn Feeders & Spare Parts	2-5
Mekikler (Mayer) Mayer Yarn Carrier Series	6-7
Mekikler (Pilotelli - Orizio) Pilotelli - Orizio Yarn Carrier Series	8
Mekikler (Terrot) Terrot Yarn Carrier Series	9
Mekikler (Diğer) Yarn Carrier Series (Other)	10-14
Mekik Yönlendiricileri Yarn Carrier Lycra Guide	15
Çelikler Cams	16-21
Mayer Yedek Parçaları Mayer Spare Parts	22-30
Orizio Yedek Parçaları Orizio Spare Parts	31-36
Pilotelli Yedek Parçaları Pilotelli Spare Parts	37-39
Terrot Yedek Parçaları Terrot Spare Parts	40-42
Albi & Vignoni Yedek Parçaları Albi & Vignoni Spare Parts	43
Uzak Doğu Yedek Parçaları Far East Spare Parts	44
Çardak & Yedek Parçaları Creel Spare Parts	45-49
Gerdirme Aparatı & Yedek Parçaları Apparatus Stretching & Spare Parts	50-51
Ölçüm Cihazları Measuring Devices	52-53
Yağdanlık ve Yedek Parçaları Oilers and Spare Parts	54-55
Muhtelif Yedek Parçalar Other Spare Parts	56-62
Seramik İplik Klavuzları Ceramic Yarn Guides	63

001

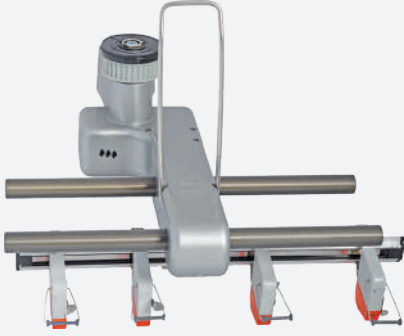

LİKRA APARATI

002

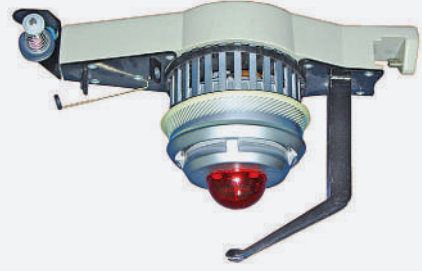

MOTORLU İRO

003

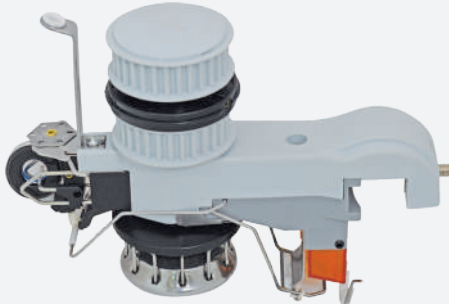

YENİ MIKNATIS SİSTEMLİ PLASTİK MEMİNGER

004



PLASTİK MEMİNGER ÇANAK SİSTEMLİ

005



LİKRA KONTAĞI (SERAMİK PİMLİ)

006



RİNGEL FURNİSÖRÜ

007



LİKRA KONTAĞI

008

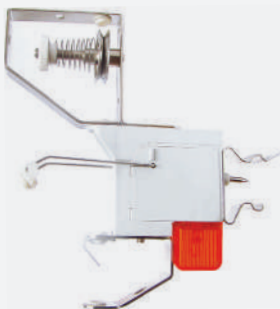

RİNGEL KONTAĞI

009



RİNGEL KONTAĞI MİSKETLİ

010



ŞÖNİL KONTAĞI

011



TT5 KEVLAR KAYIŞ

012



TT5 ÇELİK TELLİ KAYIŞ

013



ŞANZIMAN - MOTOR KAYIŞLARI

014



FURNİSÖR BANDI SUR DİŞLİ

015



FURNİSÖR BANDI DELİKLİ

016



LİKRA APARAT KAYIŞI

017

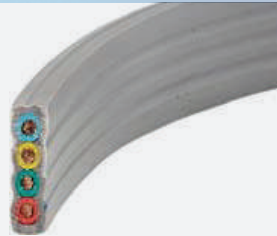

DÖRTLÜ KABLO

018



FURNİSÖR KABLOSU ÇİFTLİ

019



TRİGEL FURNİSÖR MAKARASI

020



DELİKLİ FURNİSÖR MAKARASI

021



RULMANLI DEMİR MAKARA

022



İPLİK ÇANAĞI DÜZ

023



İPLİK ÇANAĞI PİMLİ

024



FURNİSÖR MAKARASI ŞANZUMANI

025



METAL FURNİSÖR MIKNATIS YATAĞI

026



PLASTİK FURNİSÖR MIKNATIS YATAĞI

027



PLASTİK FURNİSÖR MIKNATIS YATAĞI - 2.

028



MIKNATISLI SERAMİK TAKIM - 2.

029



MIKNATISLI SERAMİK TAKIM

030



YAYLI SÜZME

031



SÜZME PULU METAL

032



SÜZME PULU SERAMİK

033



SÜZME PULU BREMZE

034



UZAKDOĞU FURNİSÖR ÖN TAKIM

035



İRO BORU TUTUCU

036



MIKNATISLI PUL TAKIM

037



LİKRA APARAT DİŞLİSİ (PLASTİK)

038



039



392 - LİKRA APARAT DİŞLİSİ - 2

040



LİKRA APARAT DİŞLİSİ - 3

041



KONTAK KABLOSU YASSI

042



KONTAK CAMI

043



FURNİSÖR MAKASI ÇOK AMAÇLI (DÜZ)

044



FURNİSÖR MAKASI ÇOK AMAÇLI L

045



FURNİSÖR MAKASI L

046



PAPATYA MAKASI

047



YONCA MEMİNGER MAKASI

048



DÜZ MAKAS

049



FURNİSÖR MAKASI Z

050

0,4 - 0,5 - 0,6 - 0,8 - 1,0



FURNİSÖR MAKASI UZUN

051



TANSİYON SAKALI (KIRMIZI)

052



TANSİYON SAKALI (SİYAH)

053



TANSİYON SAKALI (PEMBE)

054



TANSİYON SAKALI (SARI)

055



FURNİSÖR ALT TELİ

056



FURNİSÖR SERAMİĞİ

057



FURNİSÖR SERAMİĞİ

058

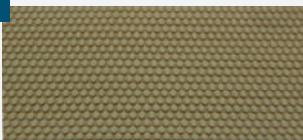

SİLİNDİR SARMA BANDI

059



SİLİNDİR SARMA BANDI

060

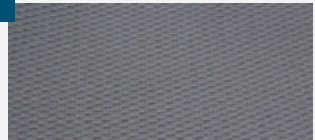

SİLİNDİR SARMA BANDI

061



MAYER RELANİT ASKI MEKİĞİ

062



MAYER ZİRKONYUM UÇ

063



MAYER ZİRKONYUM İĞNE ÖNÜ MEKİĞİ

064



MAYER ASKI MEKİĞİ

065



MAYER S4 MEKİĞİ

066



MAYER ZİRKONYUM İNTERLOK MEKİĞİ

067



MAYER RİBANA MEKİĞİ 3 DELİKLİ

068



MAYER RİBANA MEKİĞİ ÇİFT DELİK

069



MAYER RİBANA MEKİĞİ TEK DELİK

070



MAYER KAPİTONE MEKİĞİ TAKIM

071



MAYER İĞNE ÖNÜ MEKİĞİ METAL
www.seramiktektstil.com.tr

072



MAYER ZİRKONYUM İĞNE ÖNÜ MEKİĞİ

Mekikler (Mayer)
Mayer Yarn Carrier Series

073



MAYER HAVLU MEKİĞİ

074



MAYER 3 İPLİK MEKİĞİ

075



MAYER RİNGEL MEKİĞİ

076



MAYER RİNGEL MEKİĞİ

077



MAYER RİNGEL MEKİĞİ

078



MAYER RİNGEL MEKİĞİ

079



MAYER ET MEKİĞİ

080



MAYER MİNİ JAKAR SÜPREM

081



MAYER OVJA MEKİĞİ

082



MAYER OV 3.2 JAKAR MEKİĞİ

083



FİTİL MEKİĞİ

084



MAYER FİTİL MEKİĞİ

085



PİLOTELLİ ZİRKONYUM AÇIKEN MEKİĞİ

086



PİLOTELLİ ZİRKONYUM UÇ

087



ZİRKONYUM UÇ (TERS)

088



ORİZİO SÜPREM MEKİĞİ

089



ORİZİO SÜPREM MEKİĞİ (PİLOTELLİ UÇ UYG.)

090



ORİZİO HAVLU MEKİK UCU

091



ORİZİO HAVLU MEKİĞİ 314

092



ORİZİO KISA HAVLU MEKİĞİ

093

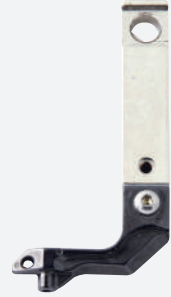

ORİZİO UZUN HAVLU MEKİĞİ

094



ORİZİO İNTERLOK MEKİĞİ

095



ORİZİO RİBANA MEKİĞİ

096



ORİZİO RİBANA MEKİĞİ

Mekikler (Terrot)

Terrot Yarn Carrier Series

097



TERROT İNTERLOK MEKİĞİ

098



RİBANA MEKİĞİ

099



TERROT RİBANA MEKİĞİ

100



TERROT RİBANA MEKİĞİ

101



TERROT RİBANA MEKİĞİ (TERS)

102



TERROT SÜPREM MEKİĞİ

104



TERROT SÜPREM MEKİĞİ (PİL. UÇ. UYG.)

105



TERROT SÜPREM MEKİĞİ

106



TERROT SÜPREM MEKİĞİ

107



SAN YOUNG İNTERLOK MEKİĞİ (TERROT UÇ UYG.)

108



TERROT KAPİTONE MEKİĞİ

109



RİBANA MEKİĞİ

110



WELLKNIT RİBANA MEKİKĞİ

111



UZAK DOĞU SÜPREM MEKİKĞİ

112



MONARCH SÜPREM MEKİKĞİ

113

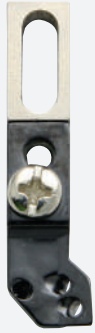

WELLKNIT AÇIKKEN SÜPREM MEKİKĞİ

114



WELLKNIT AÇIKKEN MEKİK UCU

115



JUMBERCA METAL HAVLU MEKİKĞİ - TERS

116



JUING LONG AÇIKKEN MEKİKĞİ (WEL.UÇ.UYG.)

117



JUING LONG AÇIKKEN MEKİKĞİ (PİL.UÇ.UYG.)

118



PAI LUNG AÇIKKEN SÜPREM MEKİKĞİ

119



VIGNONI AÇIKKEN SÜPREM MEKİKĞİ

120



VIGNONI ZİRKONYUM UÇ

121



PAI LUNG İPLİK MEKİKĞİ

Mekikler (Monarch)

Monarch Yarn Carrier Series

122



MONARCH SÜPREM VANİZE MEKİÇİ

123



MONARCH SÜPREM VANİZE MEKİÇİ - 2

124



MONARCH İNTERLOK MEKİÇİ

125



MONARCH SÜPREM MEKİÇİ

126



MONARCH SÜPREM MEKİÇİ

127



MONARCH SÜPREM MEKİÇİ UCU

128

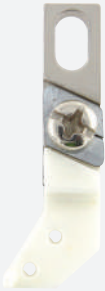

MONARCH SÜPREM MEKİÇİ

129



MONARCH SÜPREM MEKİÇİ

130



MONARCH 3 İPLİK MEKİÇİ

131



MONARCH SÜPREM MEKİÇİ

132



MONARCH RİNGEL MEKİÇİ

133



MONARCH RİNGEL MEKİÇİ

134



WILD ROSE 3 İPLİK MEKİĞİ

135



WILD ROSE 3 İPLİK MEKİĞİ

136



SAN YOUNG MEKİĞİ (PİL. TERS UÇ. UYG.)

137



WELLKNIT METAL MEKİĞİ

138



UZAKDOĞU PİLOTELLİ UÇ UYGULAMASI

139



SERAMİK UÇ UYGULAMASI

140



CAMBER SÜPREM MEKİĞİ

141



CAMBER HAVLU MEKİĞİ

142



CAMBER HAVLU MEKİĞİ UCU

143



UZAKDOĞU RİBANA MEKİĞİ

144



WELLSOFT MEKİĞİ

145



UZAKDOĞU RİBANA MEKİĞİ

146



JUMBERCA RİNGEL MEKİĞİ

147



JUMBERCA SERAMİK HAVLU MEKİĞİ

148



JUMBERCA METAL HAVLU MEKİĞİ

149



SAN YOUNG İNTERLOK SERAMİK UÇ

150



SAN YOUNG İNTERLOK METAL UÇ

151



JUMBERCA METAL HAVLU MEKİĞİ (TERS)

152

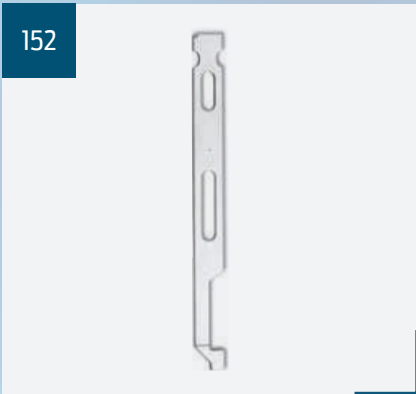

PAİ LUNG ÜÇ İPLİK MEKİĞİ

153



MAYER ÜÇ İPLİK MEKİĞİ

154



ORİZİO SÜPREM-SERAMİK MEKİĞİ

155



MAYER MV4 II ASKI ASKI MEKİĞİ

156



PAİ LUNG RİNGEL MEKİĞİ

157



MEKİK DOĞU APARATI

158



METEKS İNTERLOK MEKİĞİ

159



METEKS İNTERLOK MEKİĞİ

160



JİN LOUNG MEKİĞİ

161



PİLOTELLİ SERAMİK MEKİĞİ

162



PİLOTELLİ SERAMİK MEKİĞİ

163



ZİRKONYUM UÇ

164



CAMBER SÜPREM MEKİĞİ

165



CAMBER HAVLU MEKİĞİ

166



CAMBER MAYER OVJA MEKİĞİ

167

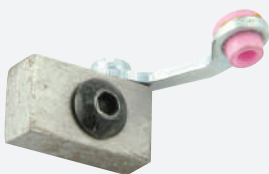

TERROT LİKRA YÖNLENDİRİCİSİ

168



RİBANA MEKİĞİ

169



ZİRKONYUM UÇ

170



VIGNONI LİKRA YÖNLENDİRİCİSİ

171



PİLOTELLİ MEKİK MAKARASI

172



PİLOTELLİ LİKRA YÖNLENDİRİCİSİ

173

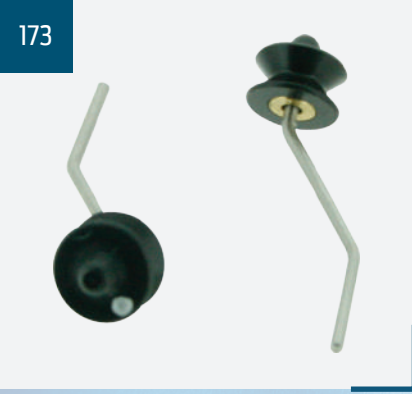

MAYER S BÜKÜM MAKARA

174



MAYER LİKRA YÖNLENDİRİCİSİ RULMANLI

175



MAYER LİKRA MAKARASI

176



MEKİK MAKARASI 10mm AVRUPA

177



MAYER İPLİK YÖNLENDİRİCİLERİ

178



TERROT LİKRA TELİ (RİBANA)

179



ORIZIO LİKRA YÖNLENDİRİCİSİ SÜPREM

180



ORIZIO LİKRA YÖNLENDİRİCİSİ RİBANA
www.seramikteksil.com.tr

181



ORIZIO LİKRA YÖNLENDİRİCİSİ AÇIK EN

182



PILOTELLİ JV3 İPTAL ÇELİĞİ

183



PILOTELLİ JV3 FANK ÇELİĞİ

184

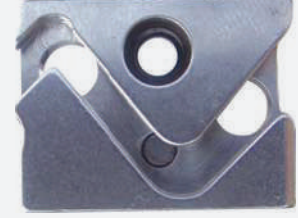

PILOTELLİ JV3 SÜPREM ÇELİĞİ

185



PILOTELLİ JV4 İPTAL ÇELİĞİ

186



PILOTELLİ JV4 FANK ÇELİĞİ

187

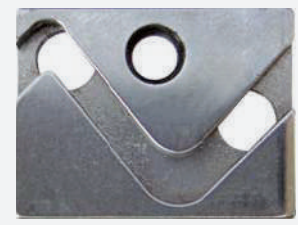

PILOTELLİ JV4 SÜPREM ÇELİĞİ

188



PILOTELLİ PLATİN ÇELİĞİ

189



PLATİN ÇELİĞİ

190



UZAK DOĞU RİBANA ÇELİĞİ

191



VİGNONI SÜPREM ÇELİĞİ

192



VİGNONI İPTAL ÇELİĞİ

193



PLATİN BAKLA ÇELİĞİ

194



ORİZİO RİBANA FANK ÇELİĞİ

195



ORİZİO RİBANA SÜPREM ÇELİĞİ

196



ORİZİO RİBANA KAPAK ÇELİĞİ

197



ORİZİO 3 İPLİK İPTAL ÇELİĞİ

198



ORİZİO 3 İPLİK FANK ÇELİĞİ

199



ORİZİO 3 İPLİK SÜPREM MEKİĞİ

200



ORİZİO JOHN C SÜPREM MEKİĞİ

201



ORİZİO BAKLA PLATİN ÇELİĞİ

202



ORİZİO PLATİN ÇELİĞİ

203

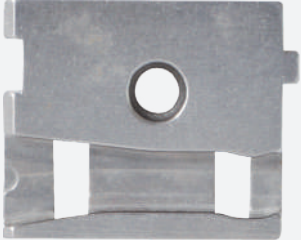

MONARCH İPTAL ÇELİĞİ

204



MONARCH FANK ÇELİĞİ

205



MONARCH SÜPREM ÇELİĞİ

206



MAYER MV4.II İPTAL ÇELİĞİ

207



MAYER MV4.II FANK ÇELİĞİ

208



MAYER MV4.II SÜPREM ÇELİĞİ

209



MAYER RELANİT İPTAL ÇELİĞİ

210



MAYER EKONİT SÜPREM ÇELİĞİ

211



MAYER MV4.II SÜPREM ÇELİĞİ

212



MAYER MV4.II PLATİN ÇELİĞİ

213



MAYER DAR PUS PLATİN ÇELİĞİ

214



MAYER RELANİT PLATİN ÇELİĞİ

215

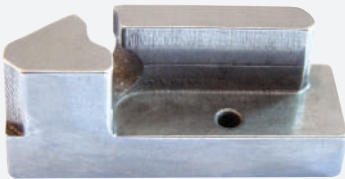

MAYER MAY ÇELİĞİ

216



MAYER İNTERLOK ÇELİĞİ

217



MAYER EKONİT İPTAL ÇELİĞİ

218



RİBANA SİLİNDİR ÇELİĞİ

219



RİBANA KAPAK ARKA ÇELİĞİ

220



RİBANA KAPAK ÖN ÇELİĞİ

221



RELANİT SÜPREM ÇELİĞİ

222



RELANİT FANK ÇELİĞİ

223



RELANİT İPTAL ÇELİĞİ

224

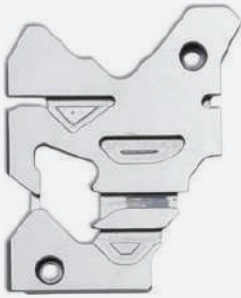

ETR ÇELİĞİ

225



MAY BASKI ÇELİĞİ

226



HAREKETLİ MAY ÇELİĞİ

227



RELANİT PLATİN ÇELİĞİ

228



TERROT PLATİN ÇELİĞİ

229



UZAK DOĞU İNTERLOK ÇELİĞİ

230



İTERLOK FANK ÇELİĞİ

231



İTERLOK İPTAL ÇELİĞİ

232



TERROT İTERLOK SÜPREM ÇELİĞİ

233

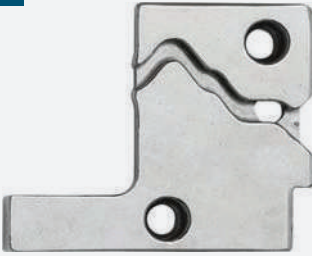

TERROT RİBANA SÜPREM ÇELİĞİ

234

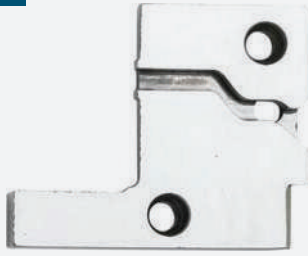

TERROT RİBANA FANK ÇELİĞİ

235

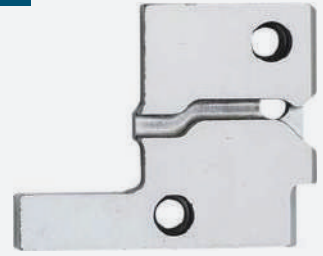

TERROT RİBANA İPTAL ÇELİĞİ

236



TERROT RİBANA KAPAK SÜPREM ÇELİĞİ

237

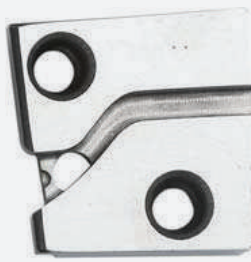

TERROT RİBANA KAPAK FANK ÇELİĞİ

238



TERROT RİBANA KAPAK İPTAL ÇELİĞİ

239



TERROT S296 SÜPREM ÇELİĞİ

240



TERROT S296 FANK ÇELİĞİ

241



TERROT S296 İPTAL ÇELİĞİ

242



TERROT PLATİN ÇELİĞİ YAPRAĞI

243



TERROT MAY SALLYANGOZU

244



MAY SALLYANGOZU

245



TERROT MAY SALLYANGOZU

246



PİLOTELLİ MAYI

247



PİLOTELLİ MAYI

248



PİLOTELLİ ÇELİK VİDASI

249



PİLOTELLİ KAPAK VİDASI

250



ORİZİO ÇELİK CİVATALARI

251



ÇELİK CİVATASI

252



TERROT KAPAK VİDASI

253



TERROT ÇELİK VİDALARI

254



ŞANZUMAN DİŞLİSİ KISA Z18

255



ŞANZUMAN DİŞLİSİ Z31

256



ŞANZUMAN DİŞLİSİ Z51

257

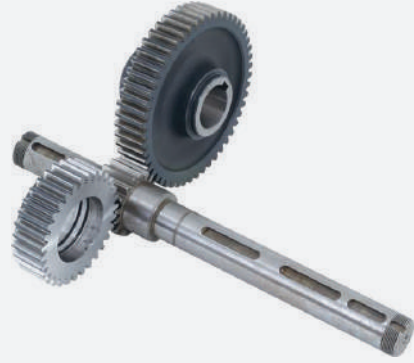

ŞANZUMAN DİŞLİSİ GRUBU Z51-Z31-Z17

258

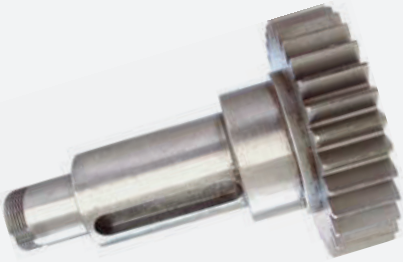

ÜST HAREKET DİŞLİSİ Z38

259



ŞANZUMAN GÖBEK HAREKET DİŞLİSİ Z30

260



AYNA MAHRUTÜ DİŞLİSİ Z11-Z33

261



AYNA MAHRUTÜ DİŞLİSİ Z11-Z33

262



ALT ÇEKTİRME HAREKET DİŞLİSİ Z16

263



ALT ÇEKTİRME HAREKET DİŞLİSİ Z16

264



ÜST GÖBEK HAREKET DİŞLİSİ

265



ALT HAREKET DİŞLİSİ Z18 MİLLİ

266



ALT HAREKET DİŞLİSİ Z28

267



ALT HAREKET DİŞLİSİ Z18

268

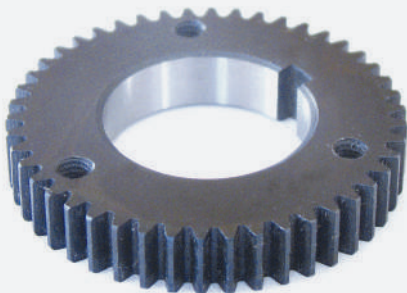

ALT ÇEKTİRME TIRNAK DİŞLİSİ

269



ALT ÇEKTİRME DİŞLİSİ

270



ALT ÇEKTİRME DİŞLİSİ Z102

271



ALT ÇEKTİRME DİŞLİSİ Z16

272



ALT ÇEKTİRME DİŞLİSİ Z22

273



ALT ÇEKTİRME DİŞLİSİ

274

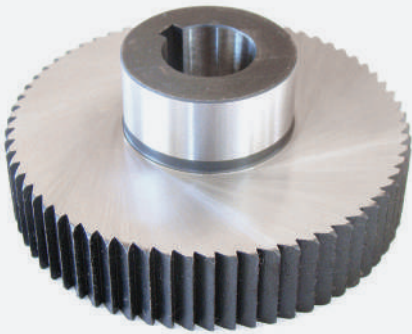

ALT ÇEKTİRME TIRNAK DİŞLİSİ SOL

275

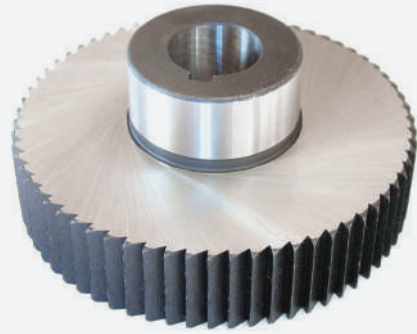

ALT ÇEKTİRME TIRNAK DİŞLİSİ SAĞ

276



ALT ÇEKTİRME TIRNAK DİŞLİSİ MİLLİ

277



BANT KASNAK DİŞLİSİ (SÜPREM ALT)

278



BANT KASNAK DİŞLİSİ (SÜPREM ÜST)

279



HAVALANDIRMA DİŞLİSİ

280



ÜST HAREKET DİŞLİSİ Z32

281



ALT ÇEKTİRME DİŞLİSİ Z102

282



ALT ÇEKTİRME ÇEKİM DİŞLİSİ Z134

283



ZİNCİR DİŞLİ

284



ZİNCİR DİŞLİ Z31

285



BANT KASNAK DİŞLİSİ

286



HAVA DAĞITICI ÇİFT PLAKA

287



HAVA DAĞITICI SÜPREM

288



TEK YÖNLÜ KOL MİLİ

289



TEK YÖNLÜ RULMAN MİLİ

290



TEK YÖNLÜ RULMAN MİLİ

291

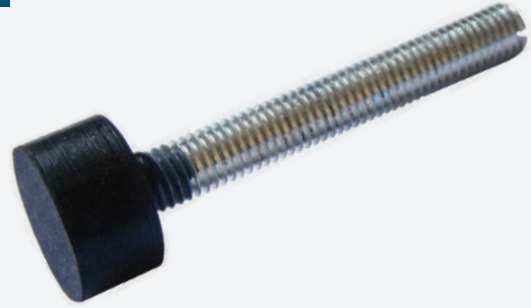

LASTİK TAKOZ

292



AYARLI KASNAK YAPRAĞI

293



AYARLI KASNAK YAPRAĞI

294



TOP SOPASI KARŞILIĞI

295



TOP SOPASI ROLLİNG TUTUCU

296

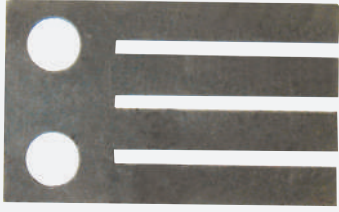

TIRNAK BASKI SACI

297



ALT ÇEKTİRME TIRNAĞI

298



EĞRİ MİL BAĞLANTI LAMASI

299



TIRNAK MİLİ

300

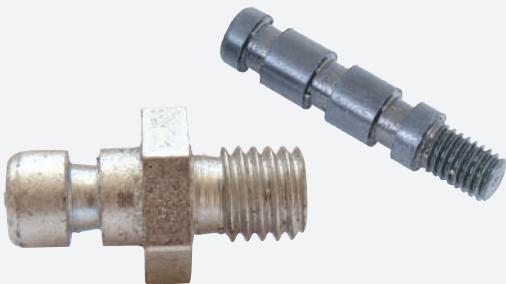

ÇEKTİRME YAY VİDASI

301



MAYER ALT ÇEKTİRME YAY GERDİRME MİLİ

302

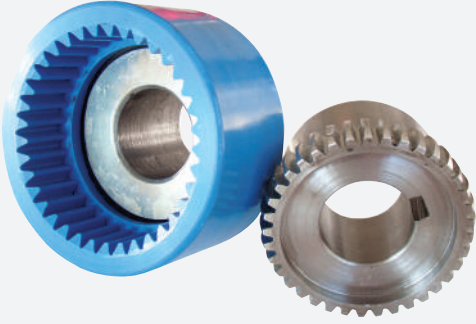

PLASTİK KAPLİN

303

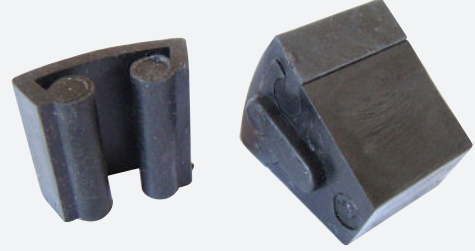

MAYER KASNAK BAKLASI 1-3-5

304



RİNGEL YÖNLENDİRİCİ TELİ

305



RİNGEL AYAK SACI

306



KÖMÜR YATAĞI

307



HAVALANDIRMA KÖMÜRÜ

308

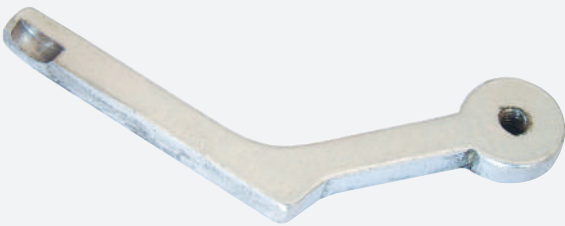

FURNİSÖR AYAĞI - CONİ

309



SUR BANT YAPIŞTIRMA APARATI

310

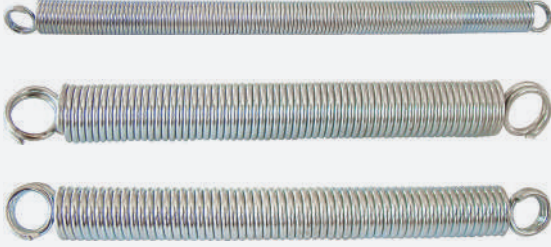

ALT ÇEKTİRME YAYI

311

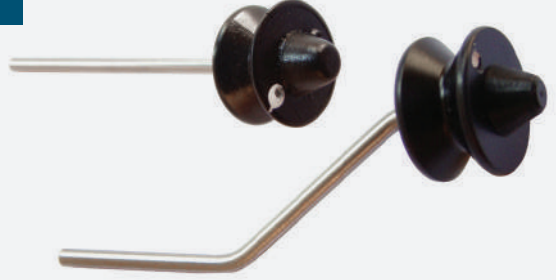

LİKRA MAKARASI

312

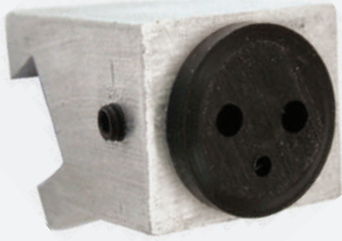

KUMAŞ KONTAĞI YATAĞI

313

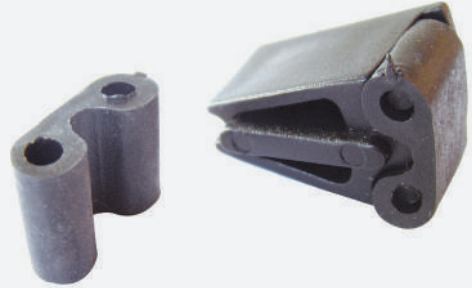

MAYER BAKLASI 1-12

314

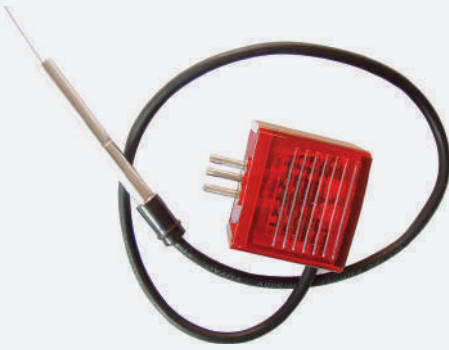

MAYER İĞNE KONTAĞI

315

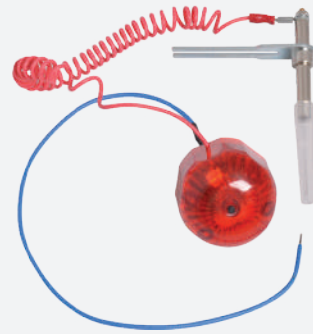

MAYER İĞNE KONTAĞI - 2

316



MAYER AÇIKEN KUMAŞ KESİM BIÇAĞI

317



MAYER KAPI KİLİDİ

318



MAYER BAND KASNAK MİLİ

319



MAYER ALT ÇEKTİRME TIRNAK FLANŞI

320



MAYER ALT ÇEKTİRME RULMAN KOLU UZUN

321



MAYER TOPSARGI MERDANE KOLU 30-34 PUS

322



MAYER ALT ÇEKTİRME EĞRİ MİL GRUBU

323



MAYER BAND KASNAK MİLİ

324



MAYER BAND KASNAK YATAĞI - ÇİFT PLAKA

325



MAYER MAY NUMARATÖRÜ

326



AYARLI KASNAK (ESKİ MODEL)

327



AYARLI KASNAK (YENİ MODEL)

328



ORİZİO YAYLI KASNAK (ESKİ MODEL)

329



ORİZİO YAYLI KASNAK (YENİ MODEL)

330



YAYLI KASNAK YAPRAĞI

331



YAYLI KASNAK YAPRAĞI

332



YAYLI KASNAK YAPRAĞI

333



YAYLI KASNAK YAPRAĞI

334



ÜST ÇEKTİRME REDİKTÖRÜ

335

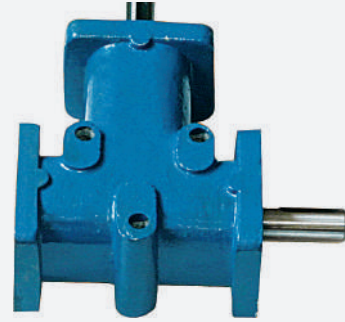

ALT ÇEKTİRME DİŞLİ KUTUSU

336



SONSUZ VİDA VE KARŞILI SARI DİŞLİ KISA TİP

337



SONSUZ VİDA VE KARŞILI SARI DİŞLİ UZUN TİP

338



KONİK DİŞLİ Z18 - Z9

339



SARI DİŞLİ VE SONSUZ VİDA VE KARŞILIĞI Z24

340



KONİK DİŞLİ TAKIMI Z25 - Z14

341



YAYLI KASNAK DİŞLİLERİ

342



TEK YÖNLÜ RULMAN MİLİ

343



MERDANE DİŞLİSİ

344



ALT ÇEKTİRME DİŞLİSİ Z14 H

345



ALT ÇEKTİRME DİŞLİSİ

346



ALT ÇEKTİRME DİŞLİSİ

347



AYARLI KASNAK DİŞLİSİ

348



BANT KASNAK DİŞLİSİ Z32 H

349



BANT KASNAK DİŞLİLERİ

350



ALT KUTU BAĞLANTISI YENİ MODEL

351



ALT KUTU BAĞLANTISI ESKİ MODEL

352



AYARLI KASNAK BAĞLANTI MİLİ

353



AYARLI KASNAK BAĞLANTI MİLİ

354



BAĞLANTI AYAĞI

355



BAĞLANTI AYAĞI

356



MERDANE GERDİRME YATAĞI

357



ALÜMİNYUM AYAK TAKOZU

358



TEK YÖNLÜ RULMAN BURCU

359



LASTİK TEKERLEK MİLİ

360



ALT ÇEKTİRME BAĞLANTI VİDASI

361

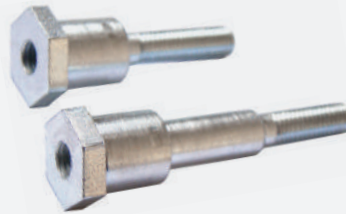

KASNAK BAĞLANTI VİDALARI

362



REDİKTÖR BAĞLANTI CİVATASI

363



BALATA

364



KAPI MIKNATISI

365



KUMAŞ KONTAĞI KABLOSU

366



PANEL

367

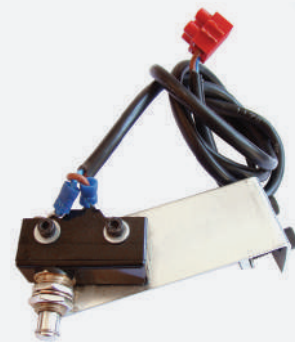

KAPI SİVİCİ

368



ORİZİO HAVA FİSFİSİ

369



ORİZİO İÇNE KONTAĞI

370



ORİZİO KAPI KİLİDİ

371



TEK YÖNLÜ RULMAN - HFL 3030

372



ORİZİO BAND KASNAK MİLİ

373



ORİZİO BAND KASNAK YATAĞI ANA MİLİ

374

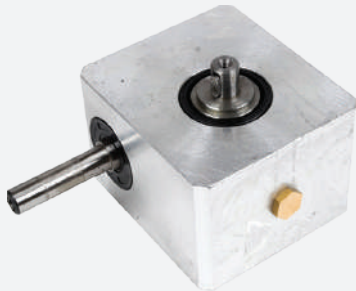

PİLOTELLİ REDÜKTÖRÜ ÜST

375



PİLOTELLİ REDÜKTÖRÜ ALT

376

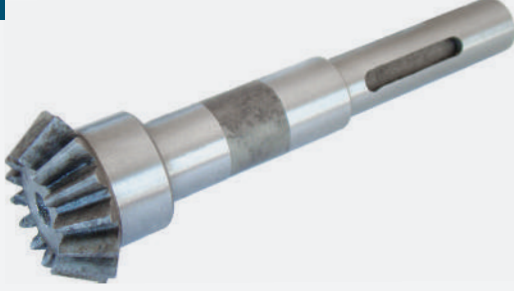

ALT KUTU KONİK DİŞLİ Z14

377



ALT KUTU DİŞLİSİ Z25

378

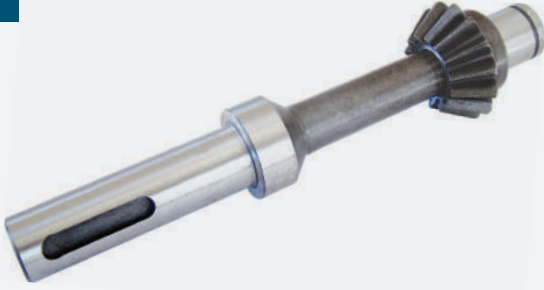

ALT KUTU DİŞLİ Z14 TERS

379



ÜST KUTU SONSUZ VİDA VE KARŞILIĞI Z39

380



ALT KUTU DİŞLİSİ

381



BAND KASNAK DİŞLİ MİLİ

382



MOTOR DİŞLİSİ

383



MOTOR DİŞLİSİ

384



ZİNCİR DİŞLİ ÇİFT KADEMELİ

385



ZİNCİR DİŞLİ YATAĞI

386



KASNAK DİŞLİSİ

387



MERDANE DİŞLİSİ

388



MERDANE DİŞLİSİ DERİN

389

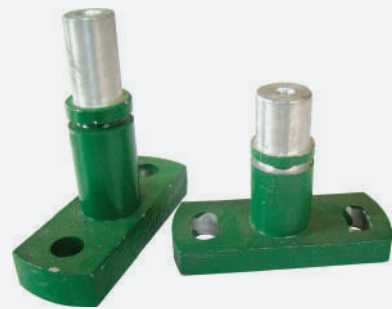

ALÜMİNYUM AYAK

390



PİLOTELLİ ŞANZUMAN DİŞLİ TAKIMI

391



PİLOTELLİ ALT ÇEKTİRME AYAĞI - TÜP

392



ZİRKONYUM KUMAŞ KESME BIÇAĞI

393



SERAMİK KUMAŞ KESME BIÇAĞI

394



PLATİN TABLASI HAVA REKORU

395



AÇICI BAĞLANTI TAKOZU

396



PİLOTELLİ PLATİN TABLASI HAVA UCU

397

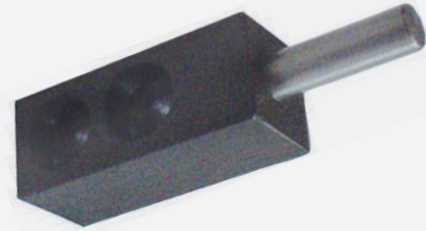

PİLOTELLİ KAPI MENTEŞESİ - AÇIKEN

398

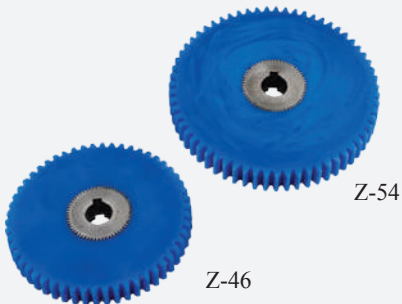

PİLOTELLİ AÇIKKEN MERDANE DİŞLİSİ

399

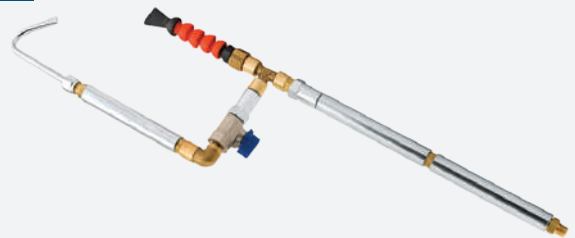

PİLOTELLİ GÖBEK HAVA BORUSU

400



BANT KASNAK DİŞLİSİ (ESKİ MODEL)

401



AÇIKEN KONİK DİŞLİSİ

402



ŞANZUMAN DİŞLİSİ (YENİ MODEL)

403



ŞANZUMAN DİŞLİSİ Z80

404



ŞANZUMAN DİŞLİSİ (YENİ MODEL)

405



ŞANZUMAN DİŞLİSİ (YENİ MODEL)

406

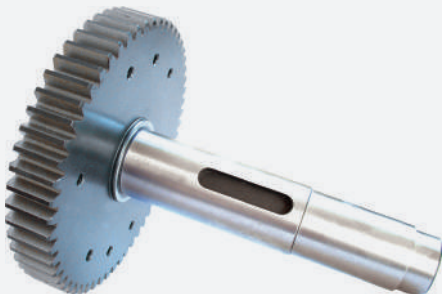

ŞANZUMAN DİŞLİSİ

407



ŞANZUMAN DİŞLİSİ Z30

408



KASNAK DİŞLİSİ (YENİ MODEL)

409



ALT HAREKET DİŞLİSİ DERLİN Z29

410



ALT HAREKET DİŞLİSİ Z29

411



ALT HAREKET DİŞLİSİ DERLİN Z29

412



ALT ÇEKTİRME DİŞLİSİ Z132

413

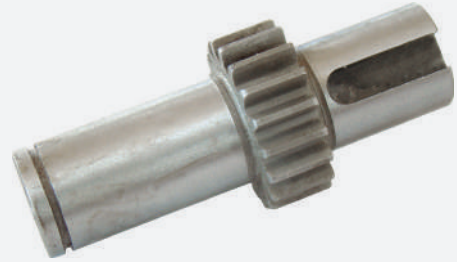

ALT ÇEKTİRME DİŞLİSİ Z16

414



ÇANAK DİŞLİSİ Z90

415



AÇIKEN ZİNCİR DİŞLİ

416

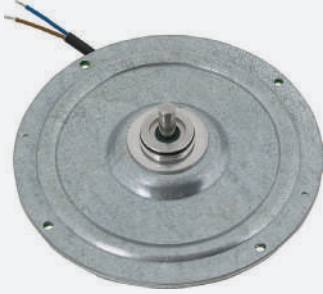

TABAK MOTORU

417



MERCOTAC

418



ŞAMZUMAN KAPLINİ ÜST

419



ŞAMZUMAN KAPLINİ ALT

420



SİGORTA SACI BÜYÜK

421



SİGORTA SACI KÜÇÜK

422



LİKRA MAKARASI PİMLİ

423



TIRNAK BASKI SACI

424



TOP ÇIKARTMA MİLİ

425



TUR AÇMA BUTONU

426



KAPAK PİMİ

427



KAPI MENTEŞESİ

428



KÖMÜR ÇEŞİTLERİ

429

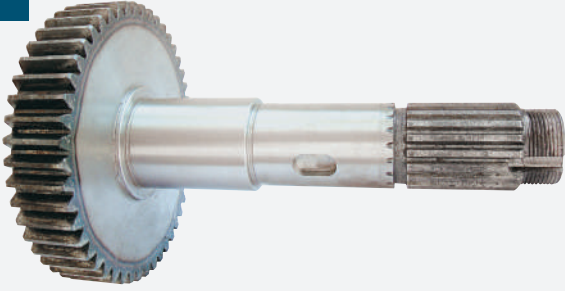

PAİ LUNG ŞANZUMAN DİŞLİSİ

430



UZAKDOĞU ÇEKTİRME DİŞLİSİ

431



UZAKDOĞU ÇEKTİRME DİŞLİSİ

432



UZAKDOĞU ÇEKTİRME DİŞLİSİ

433



WELSOFT HAV TEKERİ

434



WELSOFT HAV TEKERİ

435



UZAKDOĞU ÇEKTİRME DİŞLİSİ

436

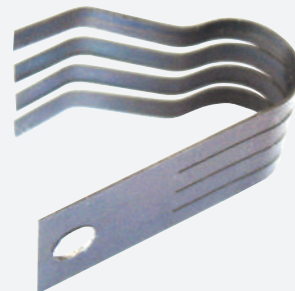

CAMBER TIRNAK BASKI SACI

437



VIGNONİ KUTU KRONİK DİŞLİSİ

438



VIGNONİ KUTU KRONİK DİŞLİSİ

439



ALBİ AYNA MAHRUTİ

440



ALBİ GÖBEK HAREKET DİŞLİSİ

441



ALBİ ALT ÇEKTİRME KONİK YAY

442



ALBİ AYNA MAHRUTİ

443



VIGNONİ AÇIKEN ALT KUTU KONİK DİŞLİ

444



VIGNONİ SONSUZ VİDA

445



ÇARDAK

446

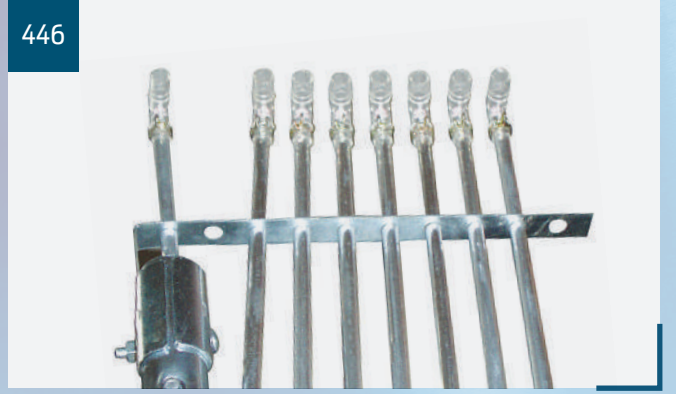

ALÜMİNYUM BORULU ÇARDAK

447



ALÜMİNYUM BORU 10-13mm

448

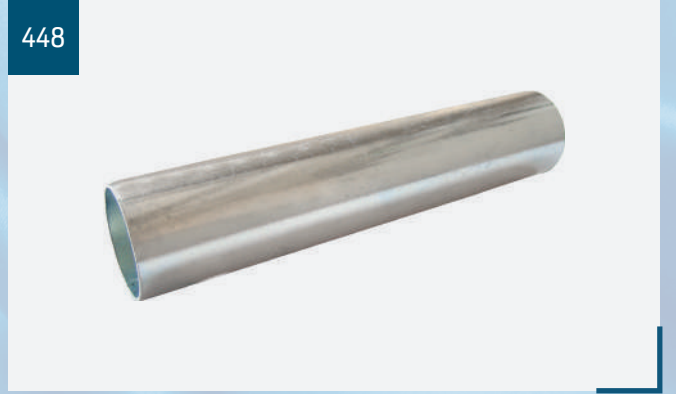

ÇARDAK BORUSU 32X1

449



BORU TUTUCU DEVE BOYNU

450



ÇARDAK NUMARATÖRÜ

451



9 BOBİN VE 9 YEDEK BOBİNLİ ÇARDAK

452

YENİ MODEL



ÇARDAK KELEPÇESİ 4 BAĞLANTILI

453



BORU TUTUCU 10'LUK

454



ÇARDAK KELEPÇESİ

455



MİL TAPASI

456

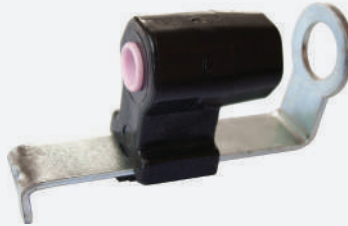

FURNİSÖR AYAĞI

457



FURNİSÖR AYAĞI

458



HUNİ AYAK - CONİ

459



DİRSEK (8-8mm)

460



DİRSEK (10-8mm)

461



DİRSEK (10-10mm)

462



DİRSEK (13-10mm)

463



DİRSEK YAYLARI

464



SIVIÇ BAĞLANTI KELEPÇESİ

465



ÇARDAK HAVA SIVIÇİ

466



SIVIÇ HAVA TESİ

467



BOBİN TUTUCU KİRPI

468



BOBİN TABAĞI

469



İPLİK YÖNLENDİRİCİSİ

470



İPLİK YÖNLENDİRİCİ YAY

471

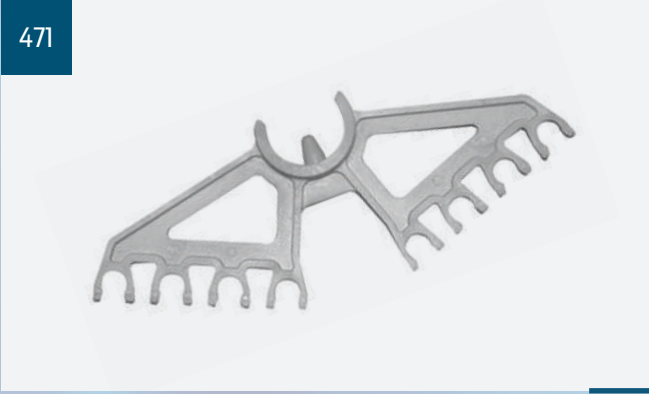

PVC BORU TUTUCU - KEÇİ BOYNUZU

472



BONCUKLU YAY

473



BÜKÜMLÜ İPLİK TUR AÇMA APARATI

474



PVC BORU MAKASI

475



BİLGİSAYARLI ÇORAP ÇARDAĞI (GENİŞ)

476



MEKANİK ÇORAP ÇARDAĞI

477



İĞNE KONTAĞI (AYAKLI)

478



İĞNE KONTAĞI

479



İPLİK YÖNLENDİRİCİ

480



ÇARDAK KONTAĞI

481

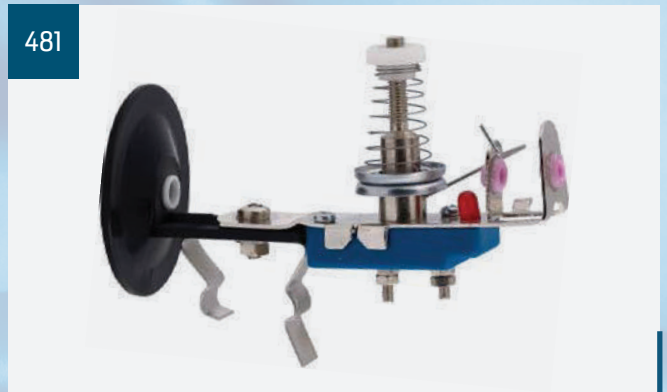

ÇARDAK KONTAĞI

482

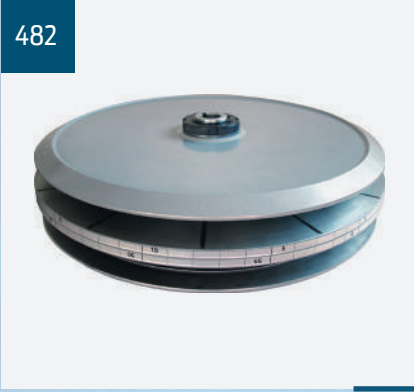

BANT KASNAĞI ÇİFTLİ 250-300

483



BANT KASNAĞI TEKLİ 250-300

484

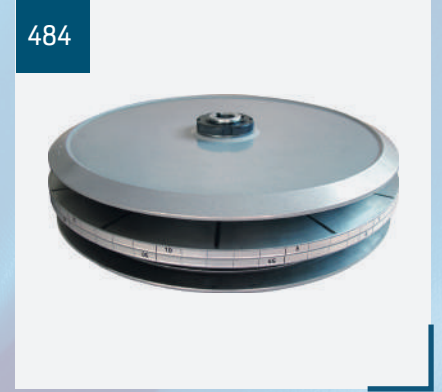

BANT KASNAĞI ÇİFTLİ 170-210

485



BANT KASNAĞI TEKLİ 170-210

486



MAYER BAKLASI 1-12

487



PİLOTELLİ 1.3.5 BAKLA TAKIMI

488



ORİZİO 1.3.5 BAKLA TAKIMI

489



TERROT BAKLASI 1-12

490



UZAK DOĞU 1.3.5 BAKLA TAKIMI

491



MAYER 1.3.5 BAKLA TAKIMI

492



KAYIŞ YAPIŞTIRMA
MAKİNASI VE İLACI

493



KAYIŞ YAPIŞTIRMA
MAKİNASI VE İLACI

494

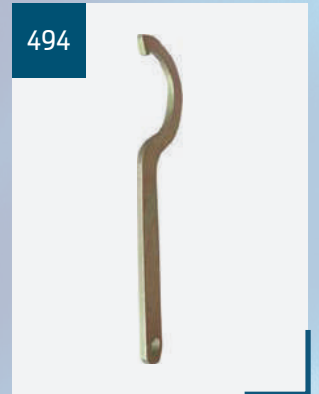

KASNAK ANAHTARI

495



YAYLI BANT GerdİRME ÇİFTLİ

496



YAYLI BANT GerdİRME ALT

497



YAYLI BANT GerdİRME ÜST

498



KAYIŞ GerdİRME DÖRTLÜ

499



KAYIŞ GerdİRME ALT ÇİFTLİ

500



KAYIŞ GerdİRME ÜST ÇİFTLİ

501



KAYIŞ GerdİRME ÜST TEKLİ

502



KAYIŞ GerdİRME ALT TEKLİ

503



GERDİRME APARATI ALT & ÜST

504



KAYIŞ TEMİZLEME TEKLİ

505



KAYIŞ TEMİZLEME ÇİFTLİ

506



FIRÇA YEDEĞİ

507



SCHMIDT İPLİK TANSİYON ÖLÇÜM ALETİ

508



DİJİTAL ÖLÇÜM ALETİ

509



ZİVY İPLİK TANSİYON ALETİ

510



KOMRATÖR SALGI SAATİ

511



KOPRATÖR AYAĞI

512

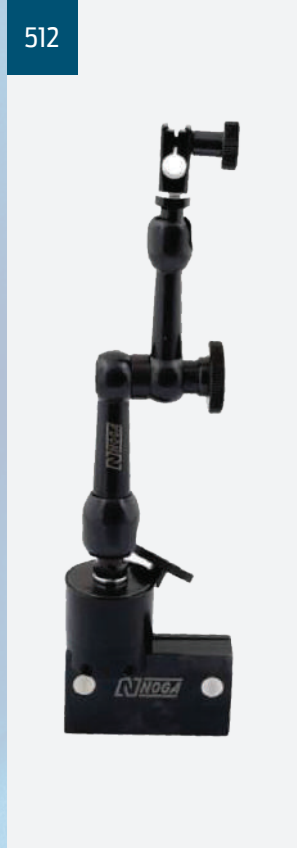

ÇELİK AYARLAMA AYAĞI

513



MEKANİK KUMPAS

514



DİJİTAL KUMPAS

515



HASSAS TERAZİ

516



GRAMAJ TERAZİSİ - MEKANİK

517



GRAMAJ KESİM ALETİ

518



GRAMAJ LASTİĞİ

519



İŞIKLI BÜÜTEÇ

520



İŞIKLI BÜÜTEÇ

521



MICROMETRE

522



GRAMAJ JİLETİ

523



MASAÜSTÜ BÜYÜTEÇ (KÜÇÜK)

524



MASAÜSTÜ BÜYÜTEÇ (BÜYÜK)

525



METAL LÜP

526

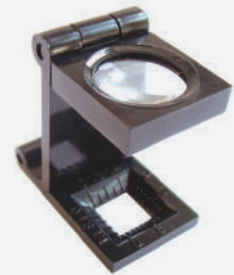

PLASTİK LÜP

527



YÜKSEK BASINÇLI ELEKTROMANYETİK YAĞLAMA SİSTEMİ

6-8-12 ayrı yağ çıkışı
3-150 saniye bekleme süresi
Kullanım ve ayar kolaylığı
Yağ bitiş uyarı sinyali
220 Volt çalışma voltajı
Sağlam ve dayanıklı malzeme
%100 yerli üretim
2 yıl garanti

TEKNİK ÖZELLİKLER

220 Volt 50 Hz. Besleme girişi
220 Volt 50 Hz. Start girişi
NC (Normalde kapalı), NO (Normalde açık) stop çıkışı
Kolay sökülüp takılabilen depo ve filtre
MIDI-5 1.5 Litre depo kapasitesi
MIDI-10 2.5 Litre depo kapasitesi
MAXI-15 4 Litre depo kapasitesi
Pompa çalışma uyarı ışıkları
Power(Güç), Start(Çalışma) ve No Oil(Yağ Bitti) ikaz lambaları
Flush(Acil Yağlama) butonu
Otomatik hortum kilitleme çıkışlar

528



YAĞDANLIK UÇLARI

529



YAĞDANLIK UÇLARI

530



YAĞDANLIK UÇLARI M6

531



YAĞDANLIK UÇLARI M5

532



YAĞDANLIK UÇLARI M6

533



YAĞDANLIK UÇLARI M5

534



HAVA REKORU

535



YAĞDANLIK UÇLARI

536



YAĞDANLIK UÇLARI

537



YAĞDANLIK UÇLARI

538



SOMUN, MAŞA VE DÜZE

539



HAVA REKORU

540



YAĞDANLIK 250cc

541



VARİL POMPASI

542



SOMUN

543



DÜZE

544



KUMAŞ MAKASI

545



KUMAŞ MAKASI

546



KARTELA MAKASI

547



İPLİK TEMİZLEME MAKASI

548



KUMAŞ KESME MAKASI

549



İĞNE PENSESİ

550



LİKRA ÇEKECEĞİ

551



İĞNE AÇICI KANCA

552



İPLİK ÇEKECEĞİ

553



İĞNE DİL AÇICI FIRÇA

554



İĞNE DİL AÇICI FIRÇA KISA

555



AYNA

556



CIMBIZ

557



CIMBIZ (RİNGEL)

558



CIMBIZ

559



KANAL BIÇAĞI

560



KANAL EĞESİ

561



İĞNE PENSESİ

562

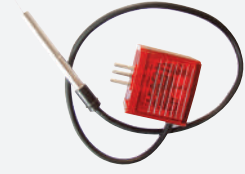

MAYER İĞNE KONTAĞI

563



MAYER İĞNE KONTAĞI - 2

564



İĞNE KONTAĞI

565



İĞNE KONTAĞI

566



TERROT KUMAŞ KONTAĞI

567



ORIZIO KUMAŞ KONTAĞI

568

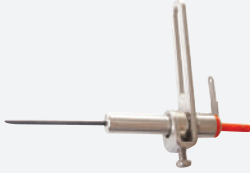

İĞNE KONTAĞI İNCE

569



İĞNE KONTAĞI

570



İĞNE KONTAĞI

571



KONTAK AMPULÜ (KABLOLU)

572



SÜZME PULU SERAMİK

573



SÜZME PULU METAL

574



KONTAK BAĞLANTI AYAĞI

575



KONTAK BAĞLANTI AYAĞI

576



KONTAK BAĞLANTI AYAĞI

577



KONTAK BAĞLANTI AYAĞI

578



STOP

579



START

580



TEPE SİNYALİ

581

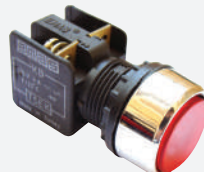

STOP DÜĞMESİ

582



START DÜĞMESİ

583



GÖBEK AMPULÜ (24V)

584



METAL DUY

585



PORSELEN DUY

586



VİDALI AMPUL (24V)

587



VİDALI AMPUL (12V)

588



PILOTELLİ SİNYAL AMPULÜ (24V)

589



SİMİT FLORASAN (22W)

590



FLORASAN LAMBA FİŞLİ

591



FLORASAN LAMBA 9W

592



FLORASAN LAMBA 4W - 6W - 8W

593



FLORASAN ORİZİO (10W)

594



FLORASAN LAMBA (10W)

595



FLORASAN AYAĞI

596



CAM SİGORTA AYAĞI

597



CAM SİGORTA

598



STARTER S2

599



STARTER (UZAKDOĞU)

600



KUMAŞ KONTAĞI AMPULÜ

601



KONTAK AMPULÜ

602



PLASTİK HAVA TABANCASI

603



PLASTİK HAVA TABANCASI - 2

604



METAL HAVA TABANCASI

605

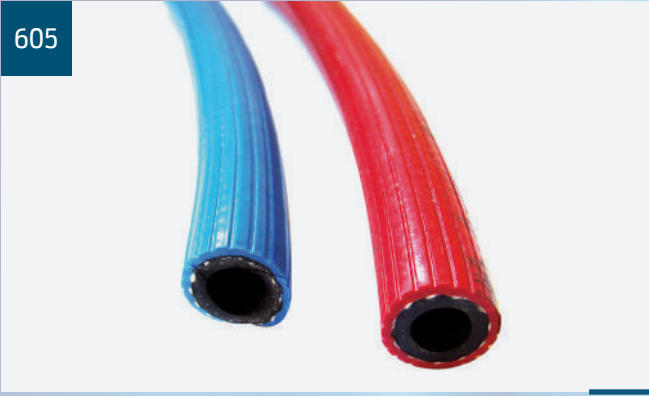

HAVA HORTUMU

606



SİRAL HORTUM 7,5mt - 15mt

607

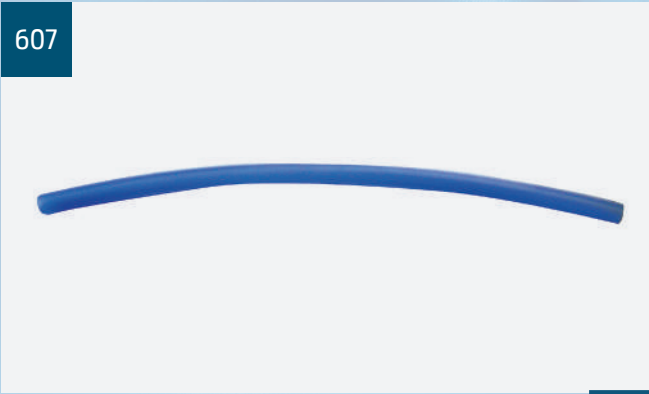

ORİZİO FIS FIS HORTUMU

608



MAKİNA HAVA HORTUMU

609



TABANCA UCU EĞRİ

610



WD-40 SPREY

611



İŞ ELDİVENİ NİTRİL

612



İŞ ELDİVENİ DERİ

613



KOLİ BANDI 45x40

614



TEFLON BANT

615



İZOLE BANT

616



502 YAPIŞTIRICI

617



KOVAN YAYI

618



KUMAŞ KODLAMA KALEMİ

619



YAĞ GÖSTERGESİ

620



SİLİNDİR SARGI BANDI

621



YILDIZ ANAHTAR TAKIMI

622



AÇIK AĞIZ ANAHTAR TAKIMI

623



ALLEN ANAHTAR

624



PENSE

625



YAN KESKİ

626



SEGMAN PENSİ EĞİK UÇ

627



GÖBEK HAVALANDIRMASI ÇİFT PANELLİ

628



HAVALANDIRMA MOTOR

629



SOĞUTUCU FAN

630



HAVALANDIRMA PERVANESİ

631



FİLTRELİ REGÜLATÖR

632



KAPI SIVİCİ DÜZ

633



KAPI SIVİCİ

634

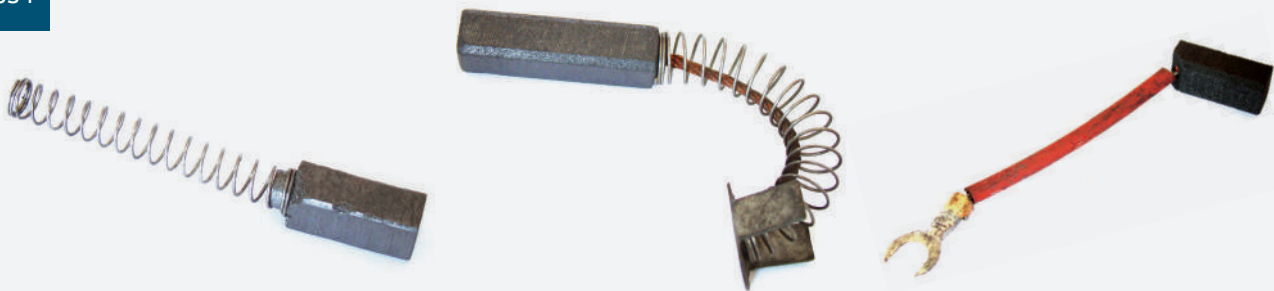

MOTOR KÖMÜRÜ ÇEŞİTLERİ
www.seramiktekstil.com.tr

635



AÇIKKEN KAPI KİLİDİ

636



FİLLER ÇAKISI (SENTİL)

637



KİLİTLİ PUL

638



KİLİTLİ SOMUN

639



TUR SAYACI

640



TUR SAYAC SENSÖRÜ

641



ÇORAP MAKİNASI TESTERESİ

642



ÇORAP MAKİNASI TESTERESİ

643



ÇORAP BIÇAĞI

644



ÇORAP BIÇAĞI

645



MEKİK BORUSU

646



MEKİK BORUSU

647



KOVAN YAYI

648



KOVAN ALTI RAYNELLERİ

649

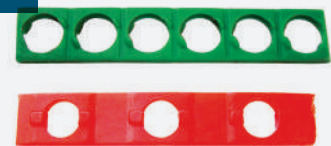

MİSKET KAFESİ





- ❑ Seramik Tekstil Makina, ikinci el tekstil makina alım satımlarında uzman ekibi ile dünya çapında hizmet vermektedir.
- ❑ Az kullanılmış makinaları uygun fiyatlarda temin ederek müşterilerimize yatırımları konusunda karlı çözümler sunmaktayız.
- ❑ Komple tesis veya tek makina alım satımlarında, makinalar istenildiği zaman revizyonlu olarak teslim edilir.
- ❑ Hizmet kalitemiz, yılların bize getirdiği bilinirlik ve müşterilerimizin bize verdiği güven sayesinde bugüne kadar dünyanın birçok ülkesinde ithalat, ihracat ve kurulum gerçekleştirdik.
- ❑ Bizi tercih ettiğiniz için siz müşterilerimize teşekkür ederiz.

2. EL MAKİNA ALIŞ VE SATIŞINDA **EN GÜVENİLİR ADRES**



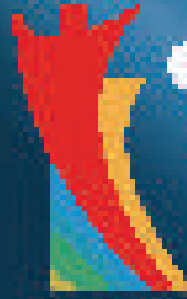

SERAMİK
TEKSTİL
MAKİNE
1984-2024

İbrahim Ağa Cad. 2. Sınıf Baş San. SH. K11 No 90
Boynampaya / İstanbul - TURKEY

Tel: (+90) 212 492 11 90 (Pbx) - Faks: (+90) 212 492 11 91

Info@seramiktekstil.com.tr - www.seramiktekstil.com.tr

